

REVEN SIB LED

PENDANT DIRECT/INDIRECT

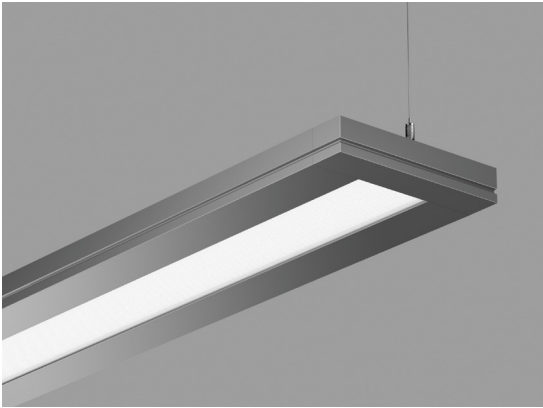

LUMENWERX
WWW.LUMENWERX.COM



Cable - shown with PMO optics

DESCRIPTION

Reven SIB (Standard Indirect Batwing) is a linear LED pendant and wall luminaire with a thin, articulated profile. Using advanced LED engines and optical control, Reven provides wide spread uplight and well controlled downlight. This highly efficient and comfortable illumination is offered in a wide range of light distributions together with comprehensive electrical and controls options. Please see additional specification sheets for Reven ICL with independently controllable light distribution, as well as other mounting arrangements.

PROJECT: _____

TYPE: _____

NOTES: _____

For 30%-70%



up to 138 lm/W performance

ORDER GUIDE

REVPSIB	PMO	LED				
LUMINAIRE ID	OPTICS	LIGHT SOURCE	CRI	LUMEN PACKAGES	COLOR TEMP.	LIGHT DISTRIBUTION
REVPSIB - Reven pendant standard indirect batwing	PMO - Precision micro-prism Optic	LED - High performance LED	80 - 80CRI 90 - 90CRI	750 - Min. low output 750lm/ft 875 - Medium output 875lm/ft 1000 - Max. high output 1000lm/ft #### - other required lm/ft	27 - 2700K 30 - 3000K 35 - 3500K 40 - 4000K	80/20 - 80% down - 20% up 60/40 - 60% down - 40% up 30/70 - 30% down - 70% up

LUMINAIRE LENGTH	VOLTAGE	DRIVER	ELECTRICAL	MOUNTING
#FT - Nominal length in feet Sections - 4', 8' and 12' only Continuous Run - for luminaires over 8' in multiples of 4'	120 - 120V 277 - 277V UNV - 120V-277V 347 - 347V (not available with Lutron)	D1 - 1% 0-10V DA - DALI LTEA2W - Lutron 1% - 2 wire FP 120V LDE1 - Lutron Hi-lume 1% Eco LDE5 - Lutron 5% EcoSystem	1 - 1 circuit + #EB - Emergency battery (min 4' fixture, except Lutron) + #EM - Emergency light circuit + #NL - Night light circuit + #GTD - generator transfer device	53WAC36 - Power 5" + non power 3" white canopy (36" aircraft cable) 55WSW18 - Power 5" + non power 5" white canopy & stem (18" stem) For all other options refer to our Pendant Mounting Guide

See page 2 for ordering code detailed information

FINISH	CONTROLS	OPTIONS
W - Matte white AL - Aluminum CF# - custom finish specify RAL#	STANDALONE CONTROLS¹ OMS - Onboard Occupancy ODS - Onboard Daylight OCS - Onboard Occupancy & Daylight CONNECTED CONTROLS CCS(O) - LU-Lutron, EN-Enlighted, OS-Osram, CR-Crestron. To specify see information on page 3 ¹ Available with 0-10V dimming, and 1 circuit options only	FU - Fuse TB# - T-bar caddy clip specify grid size TG# - Tegular caddy clip specify grid size ST - Screw Slots caddy clip CU - Custom

CROSS SECTION

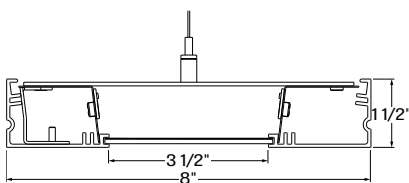

REVP - aircraft cable

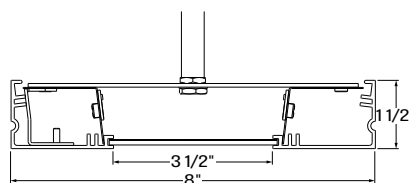

REVP - stem

OPTICS



PMO - Precision Micro-prism Optic

REVEN SIB LED

PENDANT DIRECT/INDIRECT

OPTICS

PRECISION MICRO-PRISM OPTIC (PMO) - Angled LED array with matte aluminum reflectors and precision Micro-Prism Optic (PMO) shielding of 0.1" thick acrylic. Precisely formed pyramidal prisms with a 0.06" square base provide outstanding control of high-angle brightness. Upper diffuser yields 30/70 direct/indirect distribution. The widespread upright provides a batwing distribution with peak intensity at 117° and a peak-to-zenith ratio of 2.7:1; shielding from the PMO optic provides 45° optical cut off. Upper reflectors create options for a higher downlight component. Reven is suitable for wide row spacing with a comfortable ceiling brightness gradient.

LIGHT SOURCE - LED

Custom linear array of mid-flux LEDs are mounted directly to the housing for optimal thermal performance. Available in 2700K, 3000K, 3500K and 4000K with a minimum 80 CRI and an option for 90 CRI with elevated R9 value. Color consistency maintained to within 3 SDCM. LEDs operated at reduced drive current to optimize efficacy and lumen maintenance.

All LEDs have been tested in accordance with IESNA LM-80-08 and the results have shown L80 lumen maintenance greater than 60,000 hours. Absolute product photometry is measured and presented in accordance with IESNA LM-79, unless otherwise indicated.

PERFORMANCE PER 4' AT 4000K

80/20 - 80% down - 20% up

LED output	Color Temp	Watts	Nominal Delivered Lumens	Efficacy LPW
low output	4000K	29.5	3000	102
medium output	4000K	34.5	3500	101
high output	4000K	39.5	4000	100

60/40 - 60% down - 40% up

LED output	Color Temp	Watts	Nominal Delivered Lumens	Efficacy LPW
low output	4000K	26.5	3000	113
medium output	4000K	31.5	3500	112
high output	4000K	36	4000	110

30/70 - 30% down - 70% up

LED output	Color Temp	Watts	Nominal Lumens	Efficacy LPW
low output	4000K	21.5	3000	138
medium output	4000K	25.5	3500	138
high output	4000K	29	4000	138

LIGHT DISTRIBUTION

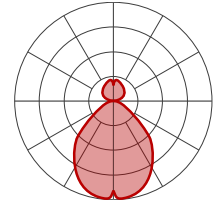
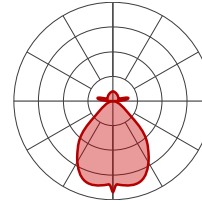

80/20 - 80% down - 20% up 60/40 - 60% down - 40% up

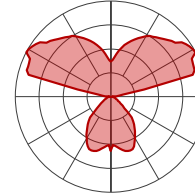

30/70 - 30% down - 70% up

LUMINAIRE LENGTH

Reven is made up of standard 4, 8 and 12 foot sections only that may be joined together to create continuous run lengths. Nominal run length required must be noted in the product code. The minimum individual section available is 4 feet. All individual sections are joined together onsite using the joiner kits provided. Lumenwerx offers joiner kits that are extremely simple to work with in the field and result in a fixture that appears virtually seamless with no light leak at any connection.

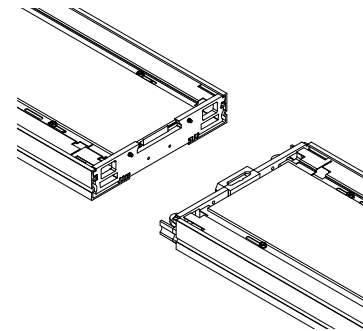

Joining system for Reven

ELECTRICAL

Factory-set, adjustable output current LED driver with universal (120-277VAC) input. Dimmable from 100% to 1% with 0-10V dimming control. Rated life (90% survivorship) of 50,000 hours at 50°C max. ambient (and 70°C max. case) temperature. At maximum driver load: Efficiency>84%, PF>0.9, THD<20%. Other specifiable options include Lutron Hi-Lume 1% (specify 2-wire, or Ecosystem Dim-to-Off), Lutron 5-Series (5% Ecosystem) and DALI protocol drivers. All of our standard 0-10V drivers are NEMA 410 compliant.

EMERGENCY

Factory installed long life high temperature recyclable Ni-Cad battery pack with test switch and charge indicator, minimum of 90 minutes operation, up to 1000 lumens per 4ft (25°C) emergency lighting output. Recharge time of 24 hours.

MOUNTING OPTIONS

Fixtures can be pendant-mounted, using aircraft cables, or stem-mounted. Unless otherwise specified, Lumenwerx provides the following hardware:

For cable-mounted fixtures - 53WAC36 (5" white canopy for all power mounting point, 3" white canopy for non power mounting point, and a 36" cable)

For stem-mounted fixtures - 55WSW18 (5" white canopy for all power mounting point, and non power mounting point, and a 18" white stem)

Caddy clips, if required specify under **OPTIONS**

[For all other options, see our website for a detailed Pendant Mounting Guide](#)

FINISH

Interior - 95%, reflective matte powder coated white paint

Exterior - Matte white or aluminum powder coating.

Custom finishes are also available.

CONTROLS

Lumenwerx offers several options for integrating occupancy and daylight harvesting controls in our luminaires.

STANDALONE CONTROLS

An integrated standalone sensor controls the luminaire in which it is installed. Depending on the length, more than one sensor may be necessary and may control the entire luminaire, or just a section of it. These controls operate independently. Unless otherwise agreed, location and functionality of the sensor within the luminaire are selected by Lumenwerx.

Three types are available:

OMS: An integral Passive InfraRed (PIR) sensor turns luminaires on and off automatically with field-adjustable time out period. No wall control is used.

Coverage pattern for large motion has a 12' diameter with the sensor mounted 8' above the floor; for small motion, the pattern has an 8' diameter. Typically, one sensor is required for every 10' of a continuous luminaire run.

ODS: An integral, daylight harvesting sensor with closed-loop operation dims the luminaire in which it is installed in order to compensate for available daylight. The sensor measures the combination of daylight and luminaire light reflected from horizontal surfaces below the luminaire. Initial onsite calibration is required via the use of provided remote control.

OCS: Both an occupancy and a daylight sensor are installed in the luminaire.

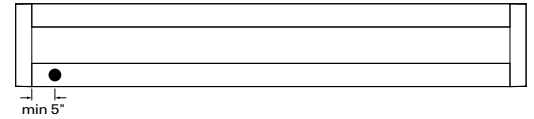

Location of an Onboard control

CONNECTED CONTROLS

With Connected Controls, sensors or nodes installed in the luminaire form part of a larger control system infrastructure from manufacturers such as: Lutron*, Enlighted, Osram ENCELIIUM, Acuity nLight, Crestron and others. These connected controls allow for a scalable system providing features like occupancy and daylight control, manual control, scheduling and configuration of various zones and scenes. Energy reporting and system monitoring are also possible. Specific capabilities depend on the control system being used.

Lumenwerx installs the components (sensors, nodes, power packs, etc) which may be supplied to us by a third party, or procured directly by Lumenwerx, depending on the control system manufacturer.

Lumenwerx is solely responsible for the installation of specified components; the controls manufacturer is responsible for performance of the control system.

To indicate a Lumenwerx luminaire with Connected Controls, identify the specific onsite control system to be integrated into the luminaires using the ordering code. Due to the diversity of components, you must contact controls@lumenwerx.com to assure complete compatibility with intended control system and to fully specify the luminaire.

Complete control specifications, sensor/node/power pack layout, and narrative for the control system are required for Lumenwerx to create shop drawings and submittals.

* Lumenwerx offers a Lutron Vive-Enabled fixture option using either the DFCSJ-OEM-OCC (OCS Option) or DFCSJ-OEM-RF (wireless only, no sensor) Integral Fixture Modules and a DALI or EcoSystem LED driver based on customer dimming requirements.

Please contact our controls department at controls@lumenwerx.com for further assistance.

CONSTRUCTION

Housing - Extruded aluminum 0.075" nominal, matte white or aluminum powder coating. Custom finishes are also available.

End cap - Die cast aluminum (0.95" nominal)

Joiners - Male/female system made in die cast aluminum (0.95" nominal)

Interior brackets - Die formed cold rolled sheet steel 20 gauge thick

Reflectors - Flat rolled aluminum sheet 0.040" thick precisely die formed, 95% reflective matte white painted

Hanger - Chromed griplock securely attached with spring steel hardware in end caps and/or joiners

Aircraft cable suspension - 7x7 braids aluminum aircraft cable 0.06" thick

Stem - 0.5" diameter threaded steel tube matte white or aluminum powder coating. Custom finishes are also available.

WEIGHT

Reven 4ft - 9.91lbs - 4.5kg

Reven 8ft - 19.16lbs - 8.7kg

Reven 12ft - 28.41lbs - 12.9kg

CERTIFICATIONS

ETL - Rated for Indoor Dry/Damp locations. Conforms to UL Standard 1598 and certified to CAN/CSA Standard C22.2 No. 250.0.

DLC - Testing to DLC requirements, for this product, have been completed by an Accredited Laboratory and certified by DLC.

WARRANTY

Lumenwerx provides a five-year limited warranty of electrical and mechanical performance of the luminaires, including the LED boards, drivers, and auxiliary electronics. Lumenwerx will repair or replace defective luminaires or components at our discretion, provided they have been installed and operated in accordance with our specifications. Other limitations apply, please refer to the full warranty on our website.

REVEN SIB LED

PENDANT DIRECT/INDIRECT

PERFORMANCE AT 80/20 - 80% down - 20% up

750 LUMEN AT 80CRI - LOW OUTPUT

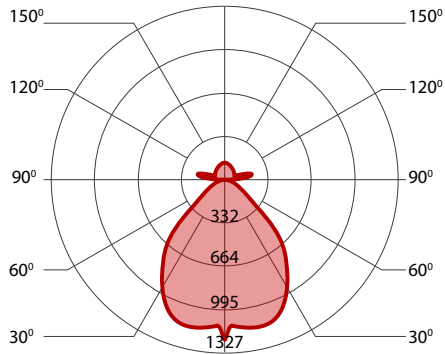

PERFORMANCE PER 4'

LED output	Color Temp	Watts	Nominal Delivered Lumens	Efficacy LPW
low output	2700K	31.5	3000	96
low output	3000K	31	3000	97
low output	3500K	30.5	3000	98
low output	4000K	29.5	3000	102

875 LUMEN AT 80CRI - MEDIUM OUTPUT

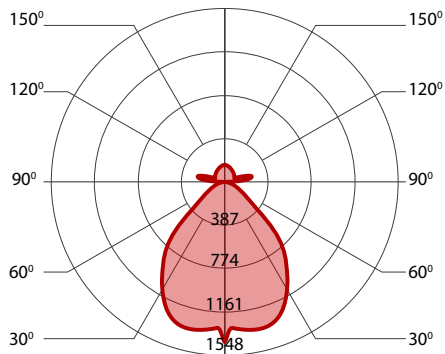

PERFORMANCE PER 4'

LED output	Color Temp	Watts	Nominal Delivered Lumens	Efficacy LPW
medium output	2700K	37	3500	95
medium output	3000K	36	3500	97
medium output	3500K	35.5	3500	98
medium output	4000K	34.5	3500	101

1000 LUMEN AT 80CRI - HIGH OUTPUT

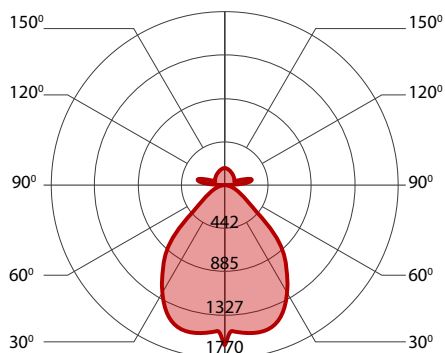

PERFORMANCE PER 4'

LED output	Color Temp	Watts	Nominal Delivered Lumens	Efficacy LPW
high output	2700K	42.5	4000	95
high output	3000K	42	4000	96
high output	3500K	41	4000	97
high output	4000K	40	4000	100

REVEN SIB LED

PENDANT DIRECT/INDIRECT

PERFORMANCE AT 60/40 - 60% down - 40% up

750 LUMEN AT 80CRI - LOW OUTPUT

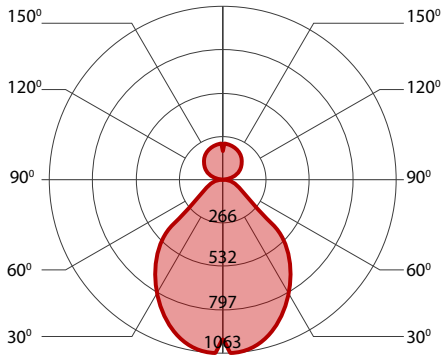

PERFORMANCE PER 4'

LED output	Color Temp	Watts	Nominal Delivered Lumens	Efficacy LPW
low output	2700K	28.5	3000	105
low output	3000K	28	3000	107
low output	3500K	27.5	3000	110
low output	4000K	26.5	3000	113

875 LUMEN AT 80CRI - MEDIUM OUTPUT

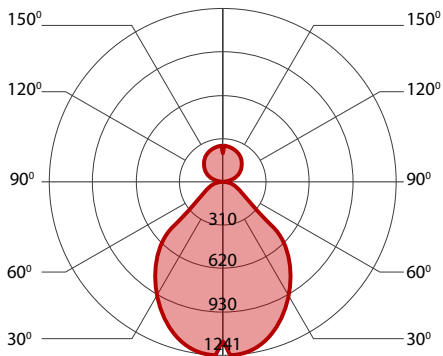

PERFORMANCE PER 4'

LED output	Color Temp	Watts	Nominal Delivered Lumens	Efficacy LPW
medium output	2700K	33.5	3500	105
medium output	3000K	33	3500	106
medium output	3500K	32	3500	109
medium output	4000K	31.5	3500	112

1000 LUMEN AT 80CRI - HIGH OUTPUT

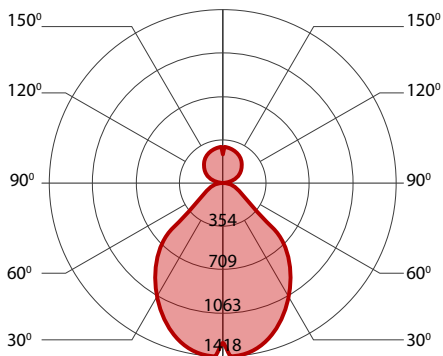

PERFORMANCE PER 4'

LED output	Color Temp	Watts	Nominal Delivered Lumens	Efficacy LPW
high output	2700K	38.5	4000	104
high output	3000K	38	4000	106
high output	3500K	37.5	4000	107
high output	4000K	36	4000	110

REVEN SIB LED

PENDANT DIRECT/INDIRECT

LUMENWERX
WWW.LUMENWERX.COM

PERFORMANCE AT 30/70 - 30% down - 70% up

750 LUMEN AT 80CRI - LOW OUTPUT

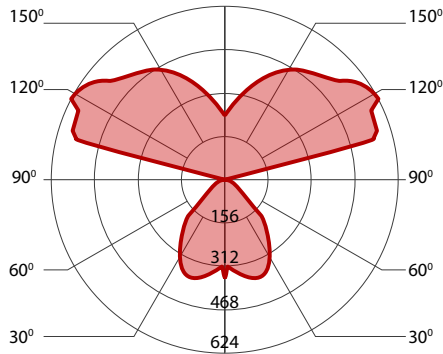

PERFORMANCE PER 4'

LED output	Color Temp	Watts	Nominal Lumens	Efficacy LPW
low output	2700K	23	3000	131
low output	3000K	22.5	3000	133
low output	3500K	22	3000	136
low output	4000K	21.5	3000	138



For 35K & 40K

875 LUMEN AT 80CRI - MEDIUM OUTPUT

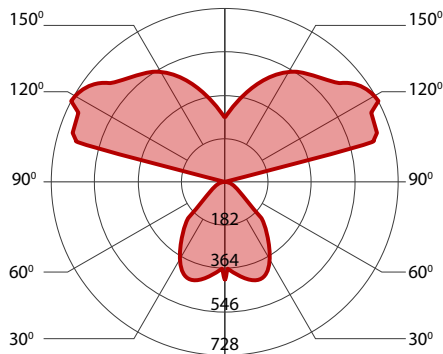

PERFORMANCE PER 4'

LED output	Color Temp	Watts	Nominal Lumens	Efficacy LPW
medium output	2700K	27	3500	130
medium output	3000K	26.5	3500	132
medium output	3500K	26	3500	134
medium output	4000K	25.5	3500	138



For 35K & 40K

1000 LUMEN AT 80CRI - HIGH OUTPUT

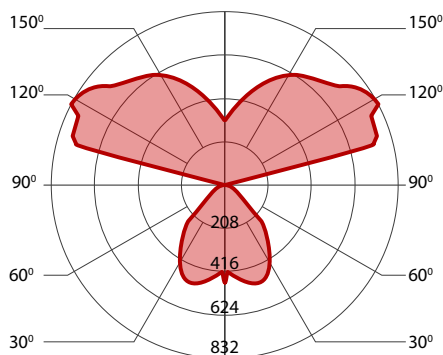

PERFORMANCE PER 4'

LED output	Color Temp	Watts	Nominal Lumens	Efficacy LPW
high output	2700K	31	4000	129
high output	3000K	30.5	4000	131
high output	3500K	30	4000	133
high output	4000K	29	4000	138



For 35K & 40K